



Vokèra

▲ DOMESTIC HEATING APPLIANCES

Maxin

24e & 28e

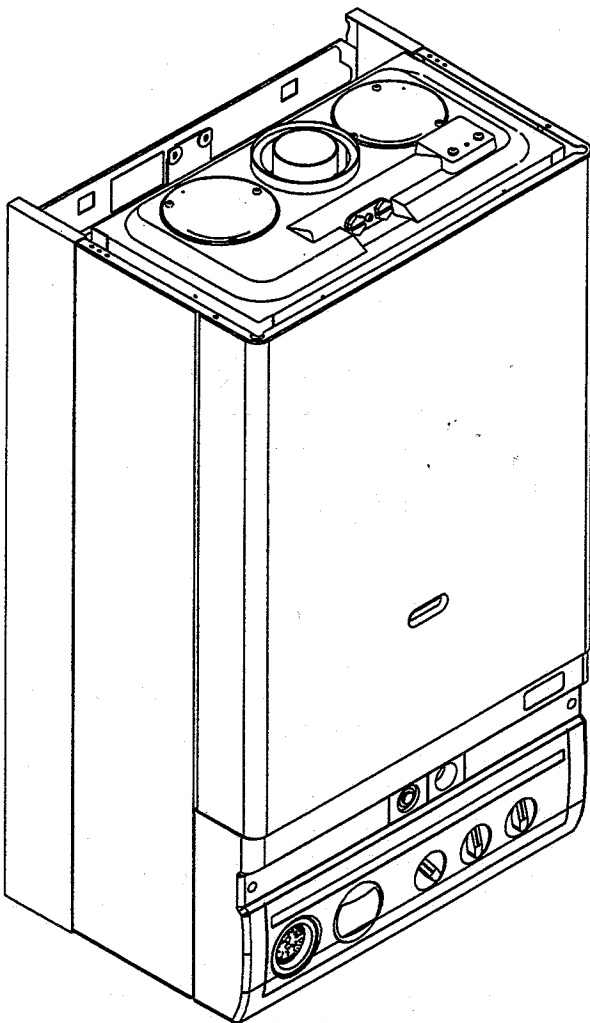

Users Instructions

CE

British Gas Service Listed
G.C. No. 47 094 22 (24e)
G.C. No. 47 094 23 (28e)

**HAND THESE
INSTRUCTIONS
TO THE USER**



BEFORE ATTEMPTING TO LIGHT APPLIANCE PLEASE MAKE SURE THAT IT IS CHARGED UP WITH WATER WITH THE NEEDLE POINTING AT 1bar ON THE PRESSURE GAUGE (7)

Gas Safety (Installation and Use) Regulations 1994

In your own interests and that of safety, it is the law that all gas appliances are installed and serviced by a competent person in accordance with the regulation.

GAS LEAK OR FAULT

IF A FAULT OR GAS LEAK IS SUSPECTED, TURN OFF THE APPLIANCE AND CONTACT YOUR INSTALLATION COMPANY, LOCAL GAS REGION OR NEAREST VOKERA OFFICE.

INTRODUCTION

Your Vokera Maxin is a central heating boiler supplying central heating and instantaneous domestic hot water only. In the winter when both Central Heating and Hot Water are needed the central heating circulation stops when hot water is being drawn off. This normally will not affect the level of heating.

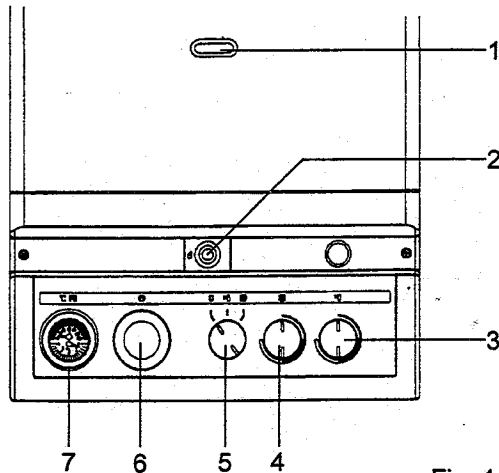

Fig. 1

Boiler Location

Clearances

- Minimum - above casing 225mm (9in)
- Minimum - below casing 200mm (8in)
- Minimum - In front 600mm (24in)
- Minimum - At sides 12mm (½in) from casing

If the appliance is fitted in a compartment it should not be used as a storage cupboard (e.g. for food).

NEVER HANG CLOTHES ETC. OVER THE APPLIANCE.

1. Sight Glass.
2. Lockout Reset Button.
3. Hot Water Temperature Control knob.
4. Central Heating Temperature Control Knob.
5. On/Off and Mode Selector switch.
6. Timeclock aperture (optional).
7. Temperature/Pressure gauge.

ELECTRICITY SUPPLY

WARNING:

THIS APPLIANCE MUST BE EARTHED

Connection should be made to a 230v 50Hz supply. The appliance must be protected by a 3amp fuse if a 13amp (BS 1363) plug or fused spur is used.

To connect a plug:

As the colour of the wires in the mains lead to this appliance may not correspond with the coloured markings identifying the terminals in your plug, proceed as follows:-

The wire which is coloured green-and-yellow must be connected to the terminal in the plug which is marked with the letter E or by the earth symbol ⏏ or coloured green or green-and-yellow.

The wire which is coloured blue must be connected to the terminal which is marked with the letter N or coloured black

The wire which is coloured brown must be connected to the terminal which is marked with the letter L or coloured red.

1.0 Hot Water Only

Ensure electricity Supply is on.

1.1 With the boiler ON/OFF/Mode selector switch (5) turned to  (Fig. 2) the main burner will ignite electronically whenever water is drawn from the tap. (view through sight glass 1)

1.2 Should the boiler fail to ignite and the lockout reset button (2) illuminates, press the button once (Fig. 3) - the appliance will reattempt ignition. Should the appliance continue to lockout the appliance must be checked by a competent person.

1.3 The temperature of water at the tap can be varied by adjusting the water flow rate at the tap. The Hot Water Temperature control knob (3) will govern the maximum temperature. Turning the knob clockwise increases the setting, anticlockwise decreases setting. (Fig. 4)

Lowest setting approx 60° C highest setting approx 80° C. The temperature gauge (7) indicates the temperature of the central heating water, not the tap water.

2.0 Heating and Hot Water

Ensure Electricity is ON.

2.1 With the boiler ON/OFF/Mode selector switch turned to  (fig. 5) (if external controls are fitted e.g. timeclock and/or room thermostat ensure they call for heat) the boiler will now go through an ignition sequence and the burner will light. (view through sight glass 1).

2.2 Should the boiler fail to ignite and the lockout reset button (2) illuminates, press the button once (Fig. 3) - the appliance will reattempt ignition. Should the appliance continue to lockout the appliance must be checked by a competent person.

2.3. Adjust the Central heating temperature control knob (4) to suit the weather, turning clockwise to increase setting anticlockwise to decrease setting. (Fig.6)

N.B (i) For the quickest heat up of the premises the highest setting is needed at first, turning down later.

(ii) When a room thermostat is used, it may be best to leave the boiler thermostat at a high setting and set the room thermostat as required.

3.0 Safety Limits

3.1 Systems pressure

The water pressure gauge (7) should read between 1bar and 1.5 bar when the system is cold. Leaks or radiator venting will reduce this. Call in your service installer if excessive topping up of the system to restore pressure is necessary.

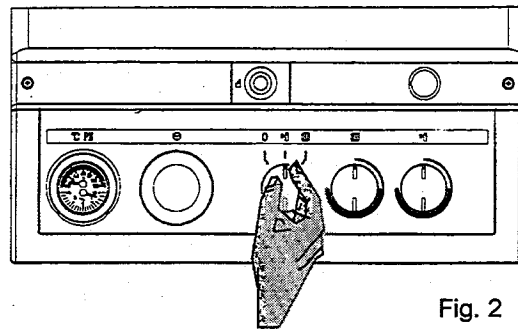

Fig. 2

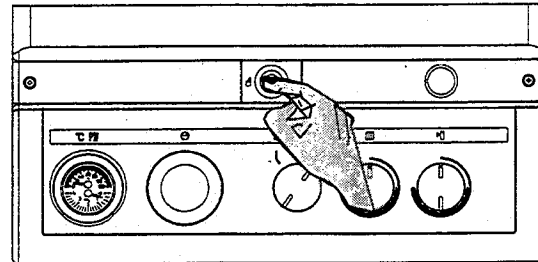

Fig. 3

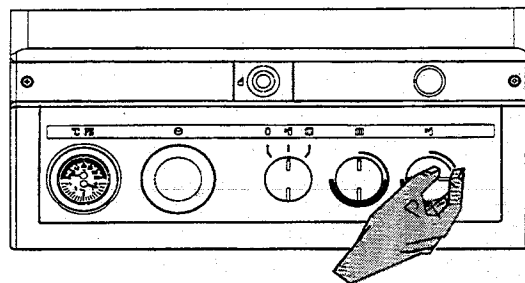

Fig. 4

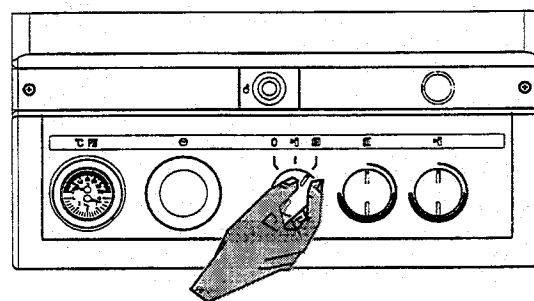

Fig. 5

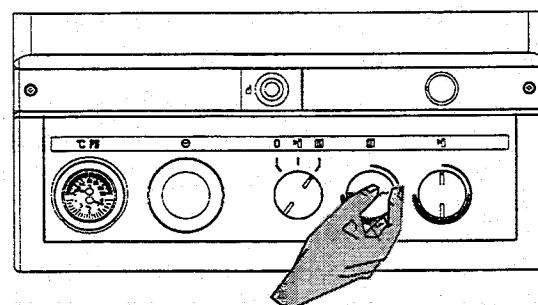

Fig. 6

A built-in safety valve operates if boiler pressure exceeds 3bar whether hot or cold. If the safety valve operates (water/steam discharges to drain) switch off and call your Installer or Service Engineer.

- 3.2 If the appliance water temperature rises too high, a high limit thermostat operates to extinguish the burner. This automatically resets when the appliance cools sufficiently.

If the High Limit thermostat operates again the appliance must be checked by your Installer or Service Engineer.

4.0 Shutting Down The System

For short periods:

Turn ON/OFF/Mode selector switch (5) to 'O' (Fig. 7)

For longer periods also:

Turn off gas cock (Fig. 8) and

Turn off main electricity supply to boiler.

However, if the building is vacated when there is risk of freezing shut down the boiler as described and drain the system: Open all heating radiator valves and drain through the cocks usually provided at the lowest point of the system. To ensure draining of radiators open radiator air vents remembering to close them when the operation is complete.

Alternatively, install a frost stat and leave the mains electricity and gas supply turned on.

- N.B. Refilling a sealed system must be undertaken by a competent person following approved procedures.

5.0 Relighting The Boiler

Relight by following steps 1.0 or 2.0 given previously, after ensuring that refilling of the sealed system has been carried out.

6.0 Cleaning The Outer Case

Use a clean damp cloth. Do not use abrasive cleaners.

7.0 Spare Parts And Servicing

Your Vokera Maxin must be serviced annually. Please contact your local Vokera Service Agent, your local Gas Region or a competent Installer.

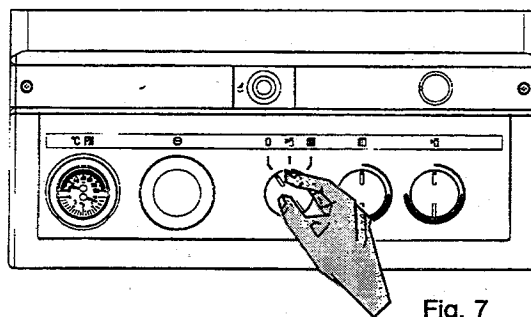

Fig. 7

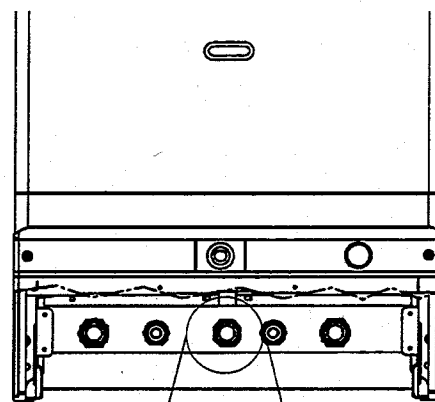
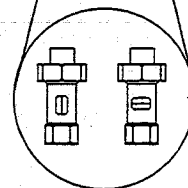

Fig. 8

Gas Cock 'ON'



Gas Cock 'OFF'

VOKERA TIME CLOCKS

MECHANICAL 24 HR VERSION

Refer Fig. 9

Setting the time.

The time of day can be set by grasping the outer edge of the black dial and turning it in a clockwise direction until the correct time is in line with the white pointer.

Setting the 'switching times'

The 'ON' periods are set by sliding the green tappets, adjacent to the time periods required, to the outer edge of the dial.

The tappets that remain at the centre of the dial will be the 'OFF' periods.

N.B. The smallest switching time (ON or OFF) is 15 minutes.

To select 'Timed' mode move the selector switch in the middle of the clock face to the ☉ position.

To select 'Constant' mode move the selector switch in the middle of the clock face to the 'I' position.

To select 'Off' mode move the selector switch in the middle of the clock face to the 'O' position.

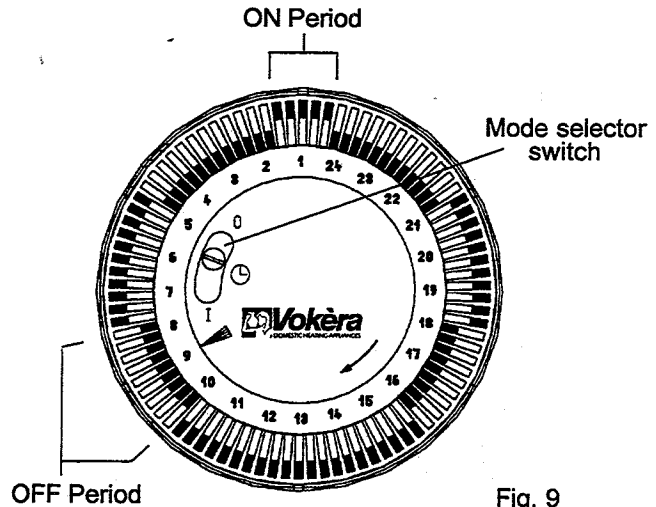

Fig. 9

DIGITAL 7 DAY VERSION

Selects ON/OFF permanently when in real time (advance)

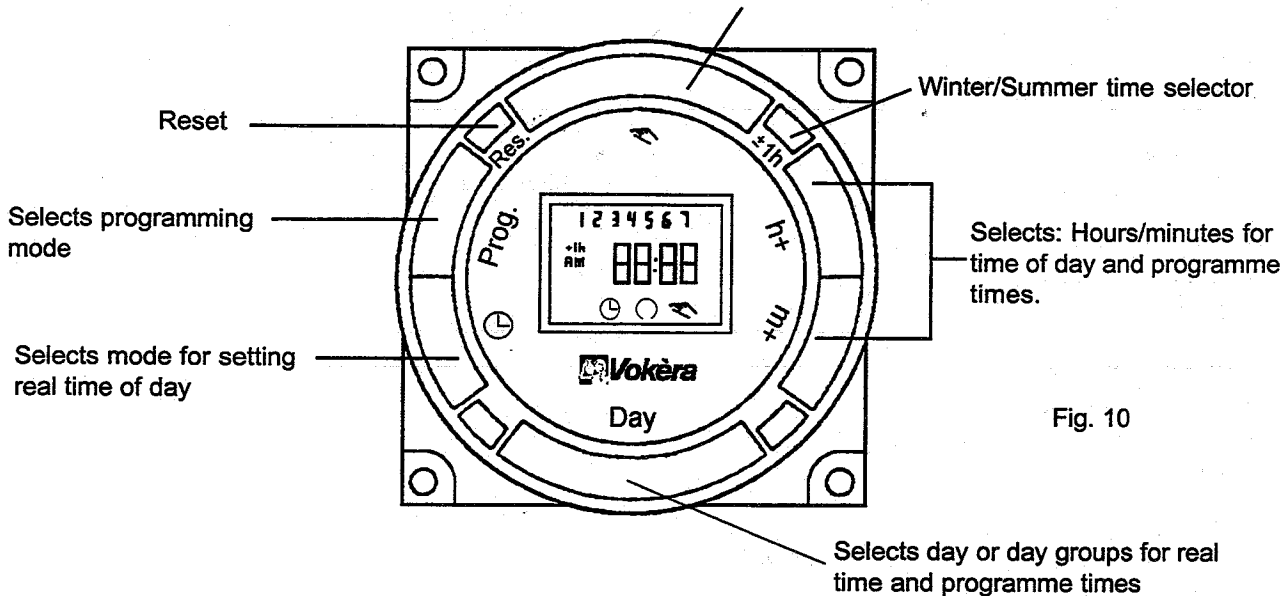

Fig. 10

SETTING INSTRUCTIONS

The Vokera digital timeswitch has besides the normal group timing facility, capacity to programme individual daily settings. It has a total of 20 storage spaces for switching operations, each space can be programmed as either an ON or OFF instruction, and can be applied to any one day or four day combinations.



SCREEN INFORMATION

Days of week 1 2 3 4 5 6 7
 ON selection ☉
 OFF selection ○
 Continuously ON ☉
 Continuously OFF ☐
 Winter/Summer time +1hr
 Timed mode ☉
 Override selection ⚡
 Programme spaces __ : __
 Number of free spaces FR





BEFORE PROGRAMMING

Press the reset button using a pencil or similar instrument. This clears the memory of unwanted information in readiness for programming. The reset button should be used in the event of local interference causing the timeswitch to appear to malfunction. Local interference dependant on location may be present from time to time.

SET CURRENT TIME AND DAY

- 1 Press and hold the  button during operations 2 - 5 below.
- 2 Press the 'Day' button to select the current weekday (1 = Monday, 2 = Tuesday etc.)
- 3 If setting in British summertime press the +/- 1h button once.
- 4 Press the 'h+' button to select the correct hour.
- 5 Press the 'm+' button to select the correct minute.
- 6 Now release the  button - the colon between the hours and minutes will flash to indicate that the clock is running.









ENTERING SWITCHING TIMES

- 1 Press the 'prog.' button to select the first free memory location.
- 2 Press the 'Day' button to select the day or group of days required for switching to occur. You have a choice of day groups: 1 - 7 (Mon - Sun), 1 - 6 (Mon - Sat), 1 - 5 (Mon - Fri), 6 - 7 (Sat & Sun), or any individual day. Each programme space automatically starts with the day selection 1 - 7. You can change this with the day button.
- 3 Press the 'h+' button to select the hour the switching is to occur.
- 4 Press the 'm+' button to select the minute the switching is to occur.
- 5 Press the  button once to select an ON  instruction, or twice to select an OFF  instruction.
- 6 Press the 'Prog.' button to store your programmed information, and select the next free programme space. Or if you have finished loading the programme press the  button which will save the programme and return the timeswitch to the current time display.
- 7 Programme further switching instructions as above.
- 8 Pressing the 'Prog.' button one additional time after you have finished programming displays the remaining number of programme spaces that are free, e.g. 'Fr 12'. If all programme spaces are full, 'Fr OO' will appear.

Important Note: After programming is completed, and you return the timeswitch to the current time display with the  button, the timeswitch will not activate any switching instruction required for the current time. You may need to manually select the desired switching state with

the  button. Thereafter, as the unit encounters further switching instructions in the memory in real time, it will correctly activate all subsequent switching instructions.

MANUAL OVERRIDE

With the  button you can manually operate the switch to switch ON or OFF outside the programmed times, or you can put the switch into a permanent ON or OFF condition. The first press of the  button advances the output to ON or OFF ( or  together with the  symbol displayed to show that the programme has been overridden) without disrupting the programme sequence. The second press fixes the output in the continuously ON  condition. The third press fixes the output in the continuously OFF  condition. In either fixed condition, the timeswitch will only revert to the timed condition if you press the  button once more.

READ OR CHANGE PROGRAMMED INFORMATION

Press the 'Prog.' button repeatedly to view each of your programmed instructions in the order in which they were programmed. You can stop to alter any of the instructions using the buttons as described in 'Entering switching times' above.

RUNNING RESERVE

In the case of mains electrical failure, the internal battery will ensure that the actual time of day continues to operate and that the automatic switching programme remains intact. The clock can be programmed completely even without mains supply, provided the battery back up is fully charged. (Charging time 70 hours approx.)

SUMMER / WINTER CHANGEOVER

From summer time to winter time: Depress the +/-1h key once (symbol +/-1h disappears from display)

From winter to summer time: Depress the +/-1h once. Display shows +/-1h symbol)

Alternatively you can follow the instructions described in 'Set current time and day' above.



Vokèra Ltd

Head Office and Accounts: Clarisham House, Morson Road, Enfield, Middlesex EN3 4NQ Tel. 0181-804 7202 Fax. 0181-804 8163

Northern Region: Stubs Beck Lane, West 26 Business Park, Whitehall Road, Cleckheaton, West Yorkshire BD19 4TT Tel. 01274 865556 Fax. 01274 865557

Scottish Region: Shuna Street, Maryhill, Glasgow G20 9NW Tel. 0141-945 4944 Fax. 0141-945 5136